



THIS DUAL SHOWER MUST BE INSTALLED BY A LICENSED PLUMBER IN ACCORDANCE WITH LOCAL REGULATIONS

This Oliveri dual shower is manufactured to standard AS/NZS 3662.

MAX OPERATING PRESSURE:5 bar (500kPa)
 RECOMMENDED OPERATION PRESSURE:1.5-5 bar (150-500kPa)
 MAX HOT WATER TEMPERATURE:65°C
 RECOMMENDED HOT WATER TEMPERATURE:50°

Where water pressure exceeds 500kPa, a pressure reducing device is required to be installed. Note that water pressure overnight can reach 150% of the daytime pressure.

Before attempting any work involving mains water supply lines, ensure the water supply is shut off.

This dual shower must be installed in accordance with these instructions.



MO36342CR



Monaco Dual Shower set CP

CARE & MAINTENANCE

Clean with a soft cloth and warm soapy water as necessary - rinse and dry after cleaning. Under no circumstances should abrasive or acid based cleaning products be used.

WARRANTY

This dual shower is warranted to be free from manufacturing defects for a period of 15 years: 15 years for main body, 2 years for plastic hand piece and shower rail, wall bracket, hose, seals, o'rings. 1 year for finish and labour.

This warranty does not cover against normal wear and will be voided if the product is misused or not installed in accordance with these instructions.

In the event this product is rendered obsolete and a replacement product is required, Oliveri Solutions Pty Ltd reserves the right to supply a product of equal substitution at their discretion.

Our goods come with guarantees that cannot be excluded under the Australian Consumer Law. You are entitled to a replacement or refund for a major failure and for compensation for any other reasonably foreseeable loss or damage. You are also entitled to have the goods repaired or replaced if the goods fail to be of acceptable quality and the failure does not amount to a major failure.

SERVICE

If the product represents a danger, or damage to property may occur, immediately shut off the water supply. If the product requires servicing, please contact your installer (preferably the one who installed it).

If the installer is satisfied that the problem is not due to poor installation, contact T2 Services Pty Ltd for assistance on:

Ph: (07) 55960738

Fax: (07) 55273353

Email: oliveri@t2services.com.au

<http://oliveri.com.au/services-and-warranty>

If a warranty service agent finds that the shower is not at fault, T2 Services Pty Ltd reserves the right to pass on any callout fee to the householder.

Installation Instructions

Monaco Dual Shower (chrome)

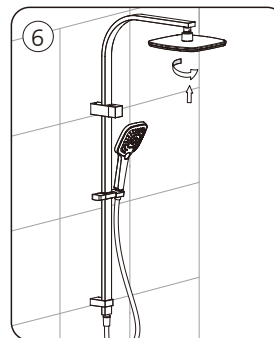
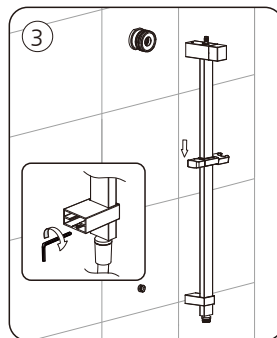
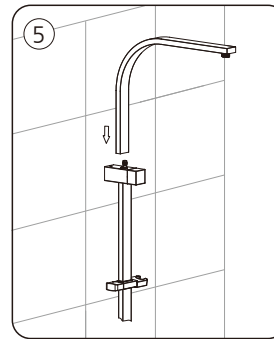
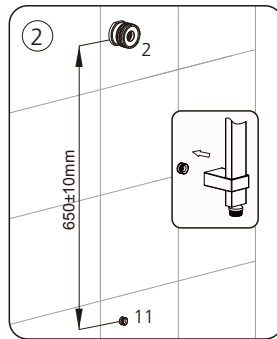
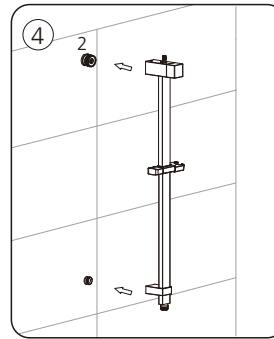
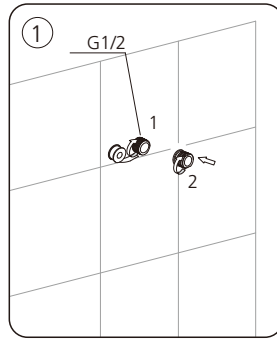
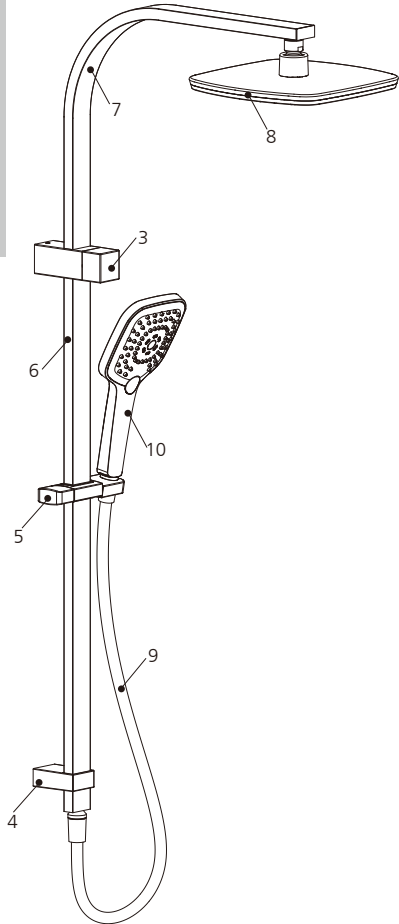

1. 1/2" BSP Male Thread
2. 1/2" BSP Connector
3. Mains Inlet Wall Post
4. Bottom Rail Post
5. Hand Piece Holder
6. Sliding Rail Tube

7. Shower Arm
8. Shower Head
9. Shower Hose
10. Hand Piece
11. Wall Bracket

General Note: This product is to be installed by a licensed plumber, installation must comply with AS/NZS 3500 and local plumbing codes.

Pressures & Temperatures

Maximum Hydrostatic Pressure - 500 kpa. (Asper AS/NZS3500)

Note: AS/NZS 3500.1-2003 (Clause 3.3.4) states that "Provision shall be made to ensure that the maximum static pressure at any outlet, other than a fire service outlet, within a building does not exceed 500 kPa.

Note: Pressures above 500kPa can cause damage from water hammer, reduced life of appliances, taps and fittings, and cause excessive noise in the system.

Minimum Hydrostatic Pressure - 100 kpa

The Maximum operating temperature for the Shower is 65°C.

Please ensure that the lines are flushed prior to installation as contaminates in the water can damage the flow regulator and also affect the performance of the Shower.

1. Remove product from packaging and check for damages, if the product is damaged do not install and return to the store of purchase.
2. The WELS compliant flow regulator has been pre-assembled in the shower head and hand piece inlet, to comply with WELS the flow regulators must remain in place.
3. From the centre of the 1/2" BSP male thread measure a level vertical line 650mm down from centre of 1/2" BSP and mark position.
4. Apply thread seal tape to the 1/2" BSP male thread (1).
5. Screw 1/2" BSP connector (2) to 1/2" BSP male thread (1) and tighten.
6. Loosen wall support bracket (4) and remove wall bracket (11).
7. Drill hole at pre-marked 650mm position to fix the wall bracket (10) to the wall, use the wall plug and screw supplied or a suitable wall plug and screw for the wall material.
8. Screw wall bracket (11) into position.
9. Feed the hand piece holder (5) from top to down of the shower rail (6).
10. Screw the sliding rail tube (6) onto the mains inlet wall post (3) ensure sealing washer is in place.
11. Slide the bottom rail post (4) onto the rail (6).
12. Tighten the wall support bracket (4) to the shower rail (6).
13. Slide the mains inlet wall post (3) onto the 1/2" BSP connector (2).
14. Align the bottom rail post (4) to the wall bracket (11).
15. Slide upper curved shower rail (6) onto main inlet wall post (3) and tighten grub screw.
16. Firmly push the shower and rail on the 1/2" BSP connector (2) and wall bracket (11).
17. Tighten both fittings with allen key supplied.
18. Screw shower hose (9) to the bottom of the shower rail (6) ensuring sealing washer is in place.
19. Screw hand piece (10) to shower hose (9) ensuring flow regulator is in the hand piece and sealing washer is in the hose.
20. Screw shower head (8) to shower arm (7) ensuring flow regulator and rubber seal is in the shower head.

To the consumer

1. **The Shower is to only be cleaned with warm soapy water**
2. **Under No Circumstances** should any abrasive, cream or acid based cleaning agents be used as these types of cleaners will damage the finish, shower head nipples and seals.